

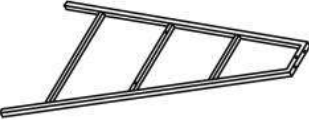











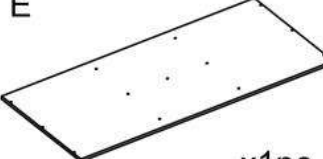
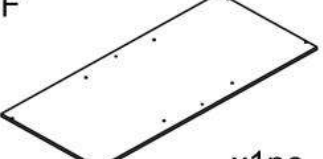

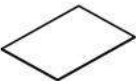







B-48

 <p>A x2pcs</p>	 <p>B x1pc</p>	 <p>C x2pcs</p>	 <p>D x2pcs</p>		
 <p>E x1pc</p>	 <p>F x1pc</p>	 <p>G x4pcs</p>	 <p>H x2pcs</p>		
 <p>I x2pcs</p>	 <p>J x2pcs</p>	 <p>K x4pcs</p>	 <p>L x1pc</p>		
 <p>M x2pcs</p>	 <p>N M6x40mm x6pcs</p>	 <p>O M6x35mm x4pcs</p>	 <p>P M6x30mm x8pcs</p>	 <p>Q M6x12mm x5pcs</p>	 <p>R x8pcs</p>
 <p>S x24pcs</p>	 <p>T x24pcs</p>	 <p>U x4pcs</p>	 <p>V x2pcs</p>	 <p>W x1pc</p>	

B-48

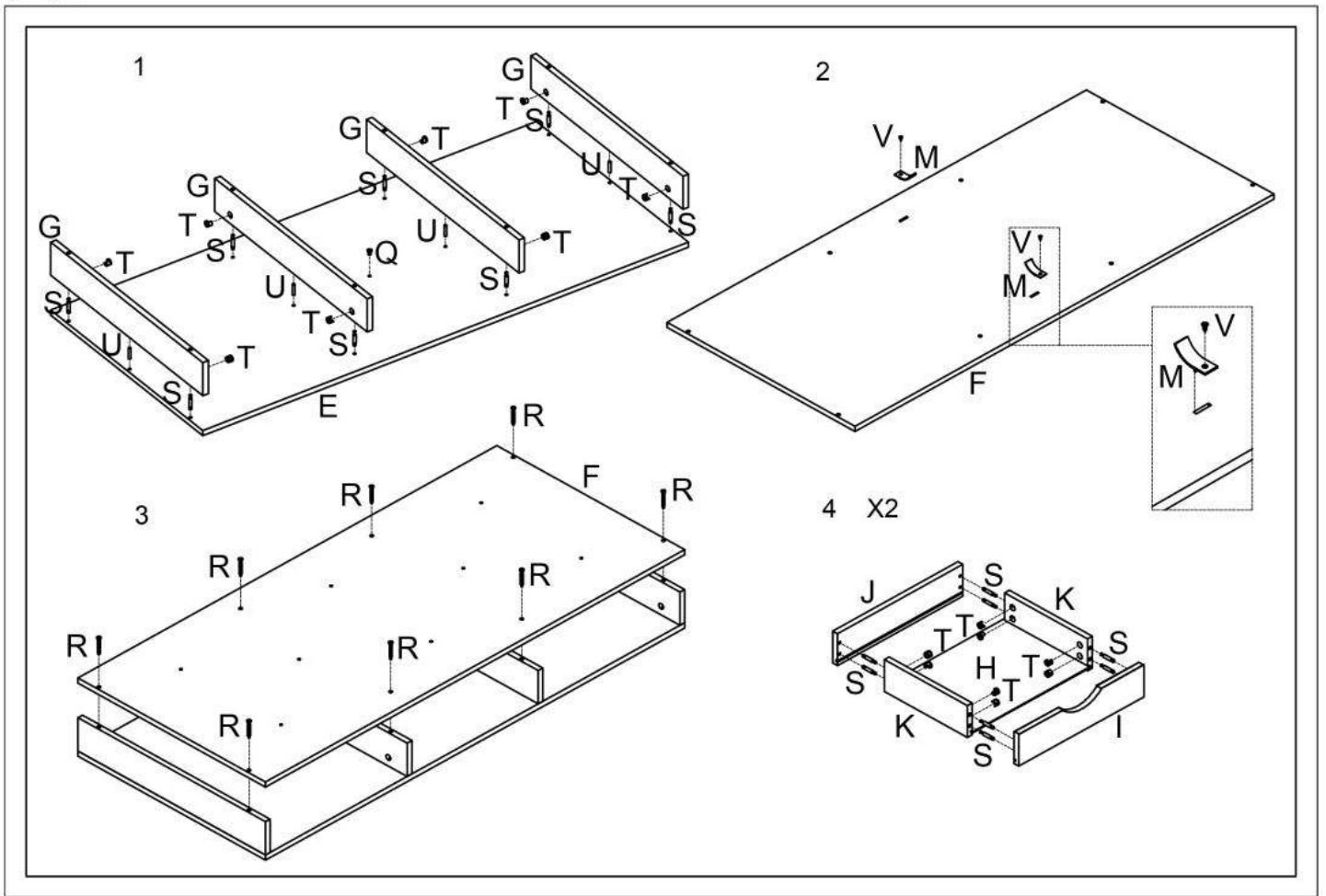

B-48

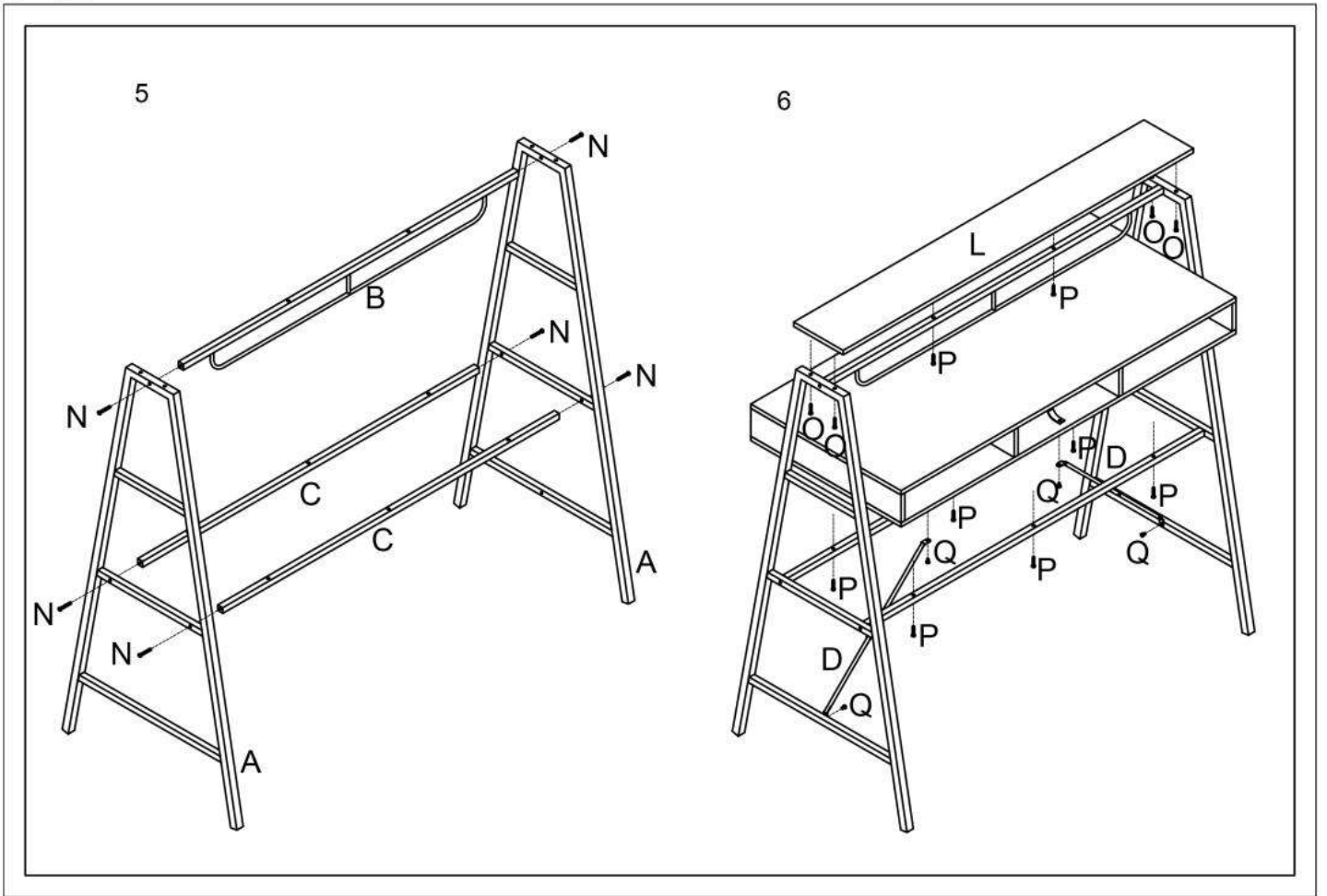

B-48

7

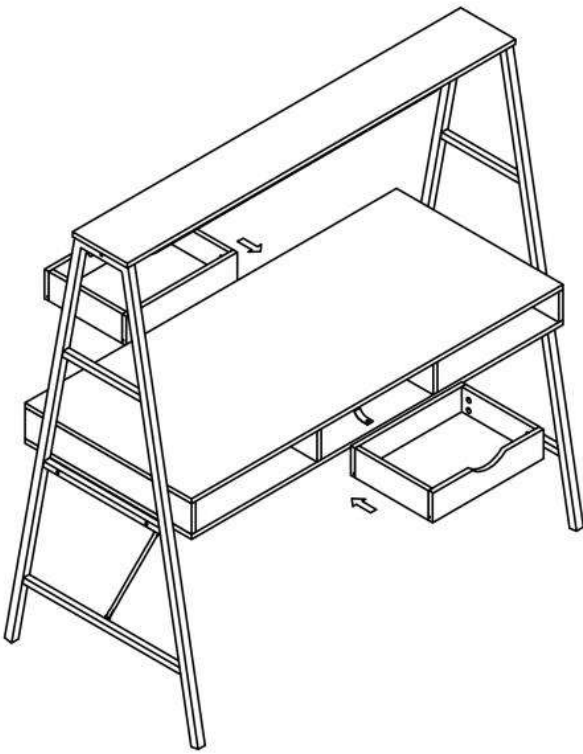

8

